

Half Surface

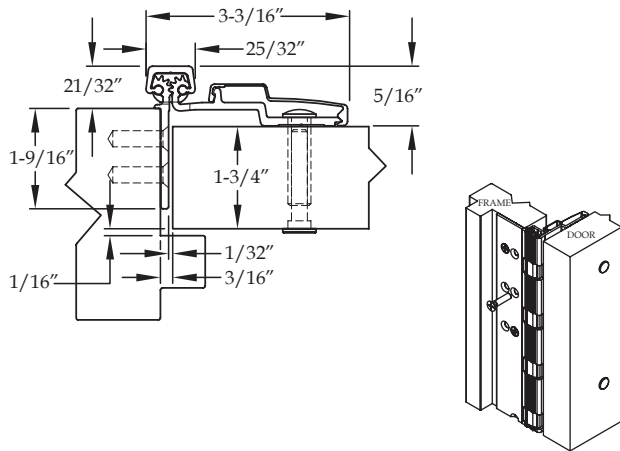

A450 HD

Standard Features

- Half surface, heavy duty
- 1/32" door inset
- 48" door width maximum
- 450 lbs. door weight maximum
- **Fasteners:** 12-24 x 7/8" undercut self-drilling, thread-forming tek machine screws for frame and 1/4-20 sex bolts and shoulder bolts for door
- **Standard lengths:** 79", 83", 85", 95" and 120"
- **Finishes:** Clear, dark bronze and black anodized
- **Fire Rating**
 - Approved for use on metal swinging type fire doors rated up to and including 90 minutes (Specify "FR" option for 3 hour rating)
 - Approved for use on wood swinging type fire doors rated up to and including 60 minutes (Specify "FR" option for 90 minute rating)

Options Available

- See pages F-7 to F-8 for option availability and details

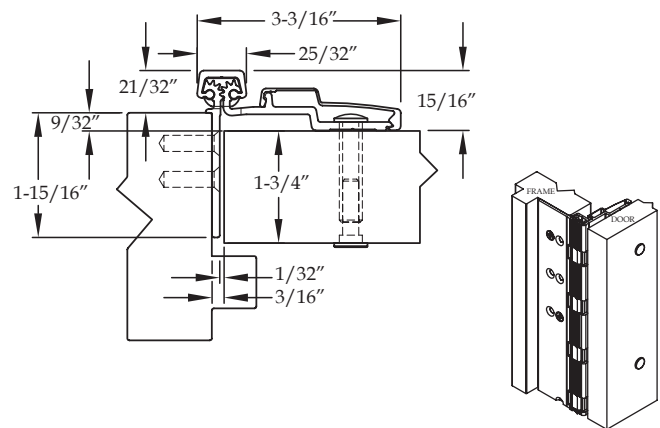

A460 HD

Standard Features

- Half surface, heavy duty
- 1/32" door inset
- 48" door width maximum
- 450 lbs. door weight maximum
- **Fasteners:** 12-24 x 7/8" undercut self-drilling, thread-forming tek machine screws for frame and 1/4-20 sex bolts and shoulder bolts for door
- **Standard lengths:** 79", 83", 85", 95" and 120"
- **Finishes:** Clear, dark bronze and black anodized
- **Fire Rating**
 - Approved for use on metal swinging type fire doors rated up to and including 90 minutes (Specify "FR" option for 3 hour rating)
 - Approved for use on wood swinging type fire doors rated up to and including 60 minutes (Specify "FR" option for 90 minuterating)

Options Available

- See pages F-7 to F-8 for option availability and details

