

# 7900 SERIES CONTROL BOXES

## CONTROL BOXES

Heavy duty, surface mounted control box contains one or two electrically controlled pneumatic circuits. Air filtration, pneumatic regulation, and system timing is performed by the control box. 7980 Series control boxes also contain a built-in air pump to power the system. Each pneumatic circuit can be adjusted for a hold open time up to 30 seconds. Output air pressure can be adjusted to precisely tailor system to individual door requirements.

Pneumatic connections use standard barbed fittings and 925 tubing from the compressor to the control box to the operator. A package of barbed tee and butt connectors are supplied with each control box to simplify installations. Consult LCN for details.

Other than a semi-annual inspection of the air filter assembly and muffler, no periodic system maintenance is required.

### 7901 AND ES7901 CONTROL BOX

For single door applications or independent control of single door in multiple door systems. Two door leaves can be operated, if they are activated simultaneously. The single pneumatic circuit accepts Normally Open (N.O.) inputs from hardwired or RF (wireless) actuator/receiver combinations. The 7901 control box requires a separate compressor.

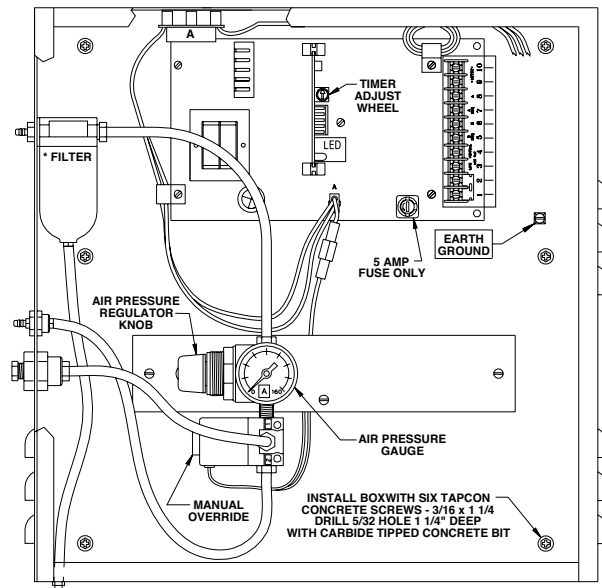

### 7902 AND ES7902 CONTROL BOX

For independent operation of two door or four door leaves, if pairs are actuated simultaneously. Two independent pneumatic circuits accept Normally Open (N.O.) inputs from hardwired or RF (wireless) actuator/receiver combinations. Sequential operation (add suffix "S") is available for 7902. The 7902 control box requires a separate compressor.

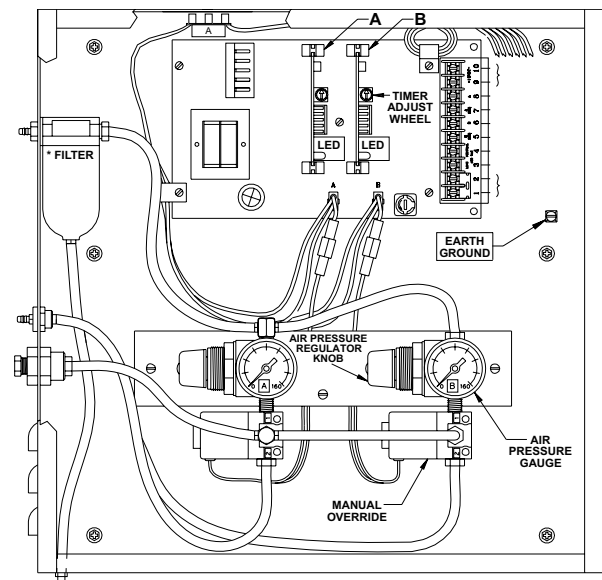

# 7900 SERIES CONTROL BOXES

## 7981 AND ES7981 CONTROL BOX

Self-contained control box/compressor combination for single door leaf applications. The single pneumatic circuit accepts Normally Open (N.O.) inputs from hardwired or RF (wireless) actuator/receiver combinations. The 7981 control box does not require a separate compressor.

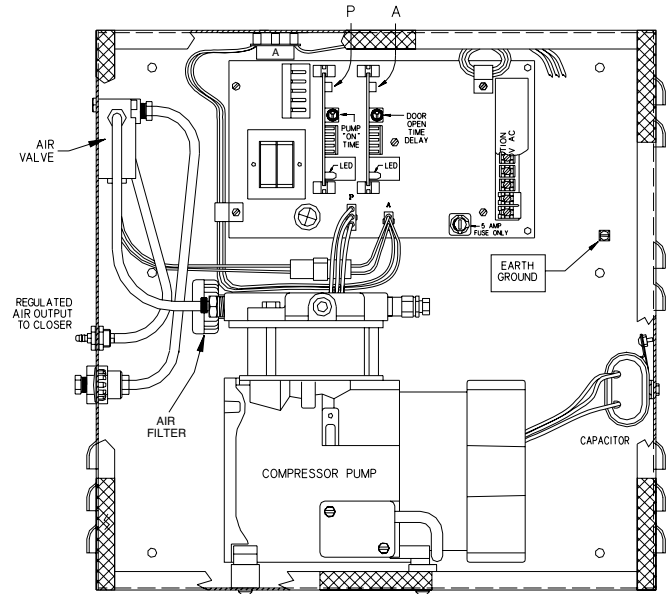

## 7982 AND ES7982 CONTROL BOX

Self-contained control box/compressor combination for independent or simultaneous operation of two door leaves. Two independent pneumatic circuit accepts Normally Open (N.O.) inputs from hardwired or RF (wireless) actuator/receiver combinations. The 7982 control box does not require a separate compressor. Sequential operation (add suffix "S") is available for 7982 control boxes.

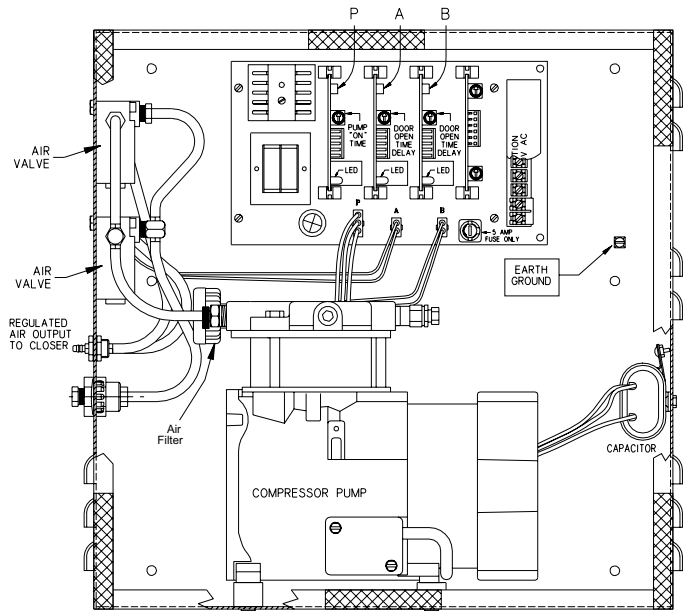

# 7900 SERIES CONTROL BOXES

## 7949 AND ES7949 CONTROL BOX

Auxiliary “blow-open” box works with or without 7901 or 7902 and one or two Auto Equalizers. Controlled by smoke evacuation system, the 7949 open the door(s) to allow fresh air into the building. Normal Auto Equalizer functions are not available when “blow-open” box is activated.

## OPTIONAL “ES” BOXES

Identical in function(s) to the basic box but includes an isolated (SPDT) relay with 1 set of Normally Open (N.O.) and Normally Closed (N.C.) contacts to control an electric strike. The LCN control box cannot power the strike. ES7949 has two sets of isolated (DPDT) contacts. Compressor size recommendations are based on normal usage for the number of operations listed. All LCN supplied auxiliary compressors include an automatic drain feature.

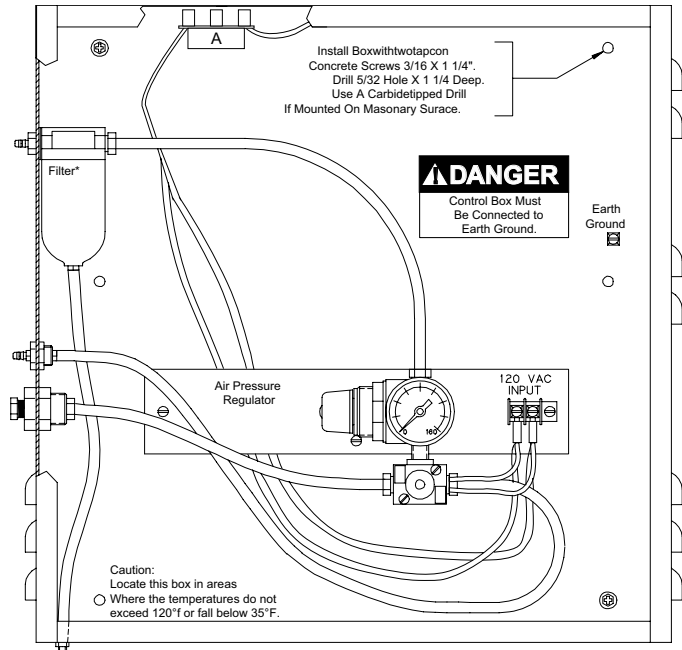

## CONTROL BOX INSTALLATION NOTES

1. Locate a 7900 Series control box so no more than 100 linear feet of LCN 925 pneumatic tubing is required between the control box and door. Maximum 50 linear feet for a 7980 and 7949 Series.
2. Locate a 7900/7980/7949 Series control box where the temperatures do not exceed 120°F or fall below 35°F.
3. 7901, 7902 and 7949 control box input 120V AC @ 1 amp. 7981 and 7982 control boxes input 120V AC @ 5 amp.
4. Output voltage is 12V DC @ 0.25 amp. max.
5. Air pressure input, 80 PSI minimum/100 PSI maximum, required for 7901, 7902 and 7949.
6. Regulated air output up to 80 PSI for Auto Equalizer.
7. Auto Equalizers require approximately 0.5 cfm airflow in heavy traffic.
8. All control boxes are 15" x 15" x 6".

# 7900 SERIES CONTROL BOX

## AIR FILTER, -329

Replacement inlet air filter for 7981 or 7982 Series control boxes.

329



## AIR FILTER, -329G

Replacement inlet air filter assembly for 7901 or 7902 Series control boxes.

329G

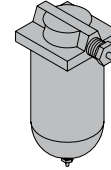

## FILTER AND SEAL, -929

Internal filter and seal component to the Air Filter -329G assembly.

929

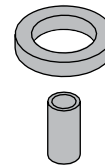

## POWER SUPPLY BOARD, -900

Main power supply/input board for the 7901, 7902, 7981, or 7982 Series control boxes.

900

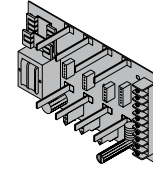

## TIMER CARD, -903

0 to 30 second timer module. Plugs into the power supply board, -900. 7901 (A slot) Series control box requires 1 each. 7902 (A/B slots) and 7981 (P/A slots) Series control boxes require 2 each. 7982 (P/A/B slots) Series control box requires 3 each.

903

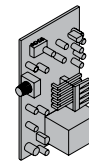

## SEQUENCER CARD, -3426

Dual, 0 to 30-second sequence timer module for 7902 and 7982 Series control boxes. Can be added to a standard 7902 or 7982 Series control box to convert to a sequential operation. Sequencer card, -3426 is included when ordering a 7902S or 7982S Series control box.

3426

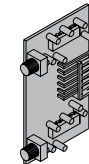

# 7900 SERIES CONTROL BOX

## VALVE ASSEMBLY, -941

Regulator valve assembly for 7901 Series control box.

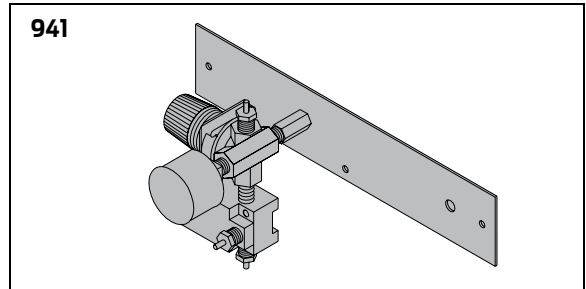

## VALVE ASSEMBLY, -942

Regulator valve assembly for 7902 Series control box.

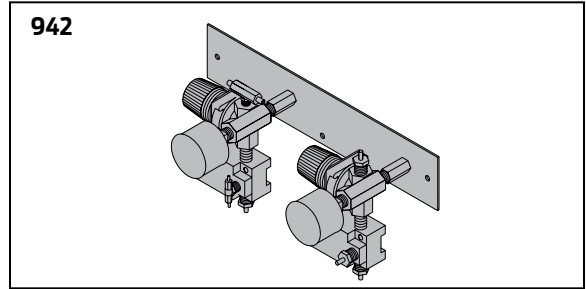

## VALVE ASSEMBLY, -941C

Regulator valve assembly for 7949 Series blow open control box.

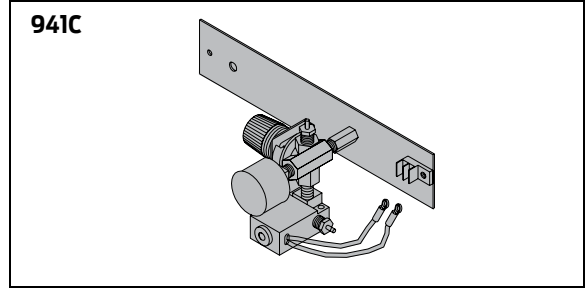

## SOLENOID VALVE ASSEMBLY, -3299A

Air valve assembly for 7981 Series control box or the 'A' circuit valve assembly for the 7982 Series control box.

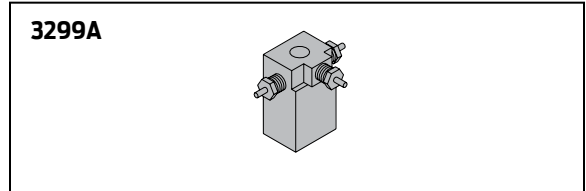

## SOLENOID VALVE ASSEMBLY, -3299B

Air valve assembly for the 'B' circuit in the 7982 Series control box.

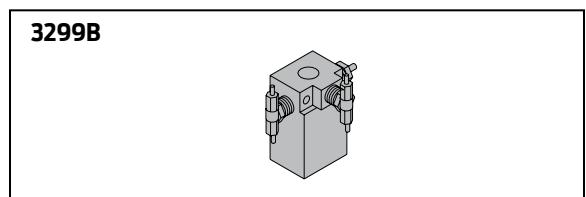

## RELAY PACKAGE 'A', -3390A

ES relay assembly for 7901 and 7981 Series control boxes or the 'A' circuit ES relay assembly in a 7902 or 7982 Series control boxes. Includes 390 relay, base, and wires. Can be added to standard 7901, 7902, 7981, or 7982 Series control boxes to convert to ES operation. Relay package, -3390A is included when ordering a 7901ES, 7902ES, 7981ES, or 7982ES Series control box.

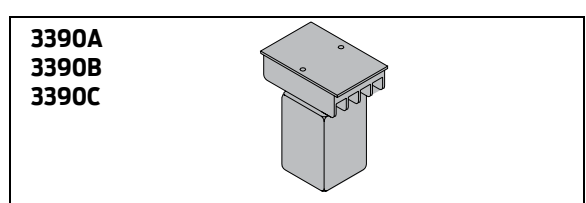

## RELAY PACKAGE 'B', -3390B

ES relay assembly for 'B' circuit in 7902 or 7982 Series control boxes. Includes -390 relay, base, and wires. Can be added to standard 7902 or 7982 Series control boxes to convert to ES operation. Relay package, -3390B is included when ordering a 7902ES or 7982ES Series control box.

## RELAY PACKAGE 'C', -3390C

ES relay assembly in 7949 Series blow open control box. Includes -390C relay, base, and wires. Can be added to standard 7949 Series blow open control box to convert to ES operation. Relay package, -3390C is included when ordering a 7949ES Series control box.

# 7900 SERIES CONTROL BOX

## ISOLATOR, -962

Rubber Isolators for 7981/7982 compressor assembly, -3960.

962

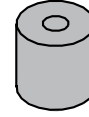

## MUFFLER, -293G

Exhaust muffler for 7901, 7902, 7949, 7981, and 7982 Series control boxes.

293G



## COMPRESSOR ASSEMBLY, -3960

Internal air pump assembly for 7981 or 7982 Series control box. Includes starter capacitor, -962 Isolators, and -329 air filter.

3960

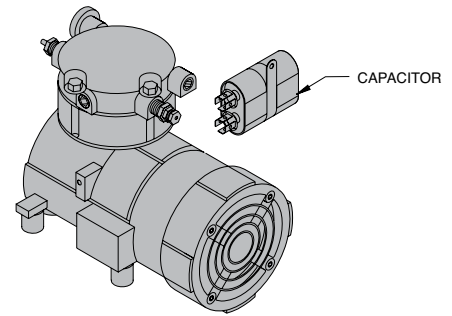

## COMPRESSOR SERVICE KIT, -3592

Internal components for pressure release valve on -3960 Compressor Assembly.

3592

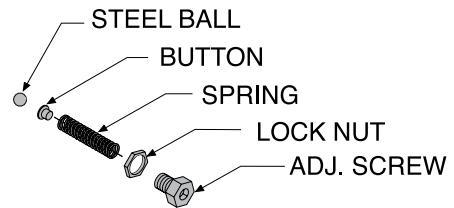

## PNEUMATIC TUBING, 925

1/8" (3mm) I.D. flexible pneumatic tubing for use with standard barbed fittings provided on pneumatic control boxes and operators. Order by linear footage required. 925 tubing is not fire-rated. Contact LCN for applications where tubing must run through rated plenums.

925

